



LMV36.520...



AGM60.4...

Basic unit with integrated fuel-air ratio control for forced draft burners

LMV36.520...

Dual fuel switch unit

AGM60.4...

The LMV36... burner management system is a microprocessor-based burner control with matching system components for the control and supervision of forced draft burners of medium to high capacity.

For using of dual fuel with 2 fuel actuators, AGM60... dual fuel switch unit is required.

The LMV36... / AGM60... and this Data Sheet are intended for use by OEMs which integrate the actuators in their products!

Use

Microprocessor-controlled basic unit for single-fuel burners of any capacity, electronic air-fuel ratio control, maximum 2 actuators, integrated gas valve proving. The system components (display and operating unit, actuators) are connected to operating on a single fuel directly to the LMV36... basic unit. All safety-related digital inputs and outputs of the system are monitored by contact feedback network. The AGM60... dual fuel switch unit connected to the LMV36... serves for changeover of valve control or for feedback signals and the actuators from the 2 types of fuel.

- Gas burner controls to EN 298: 2003
- Oil burner controls to E N230: 2005
- For forced draft gas burners to EN 676
- For oil burners with fan to EN 267

For North America

For intermittent operation in connection with the LMV36... / AGM60..., the ionization probe or the QRA... or QRC... optical flame detector can be used.

Continuous operation is possible only when using an ionization probe and without AGM60...

Features

The following components are integrated in the basic unit of the LMV36...:

- Burner management system complete with valve proving system
- Electronic fuel / air ratio control system for a maximum of 2 actuators SQM3... or SQN1...
- Control of VSD for air fan
- Modbus interface
- BCI for connection a display or PC
- Unit parameter adjustable either via display or PC software ACS410

Notes



Warning!

All safety, warning and technical notes given in the Basic Documentation of the LMV36... (P7544) also apply to this document!



Applied directives:

- Low-voltage directive 2014/35/EC
- Directive for gas-fired appliances 2009/142/EC
- Directive for pressure devices 97/23/EC and
2014/68/EC (2016-07-16)
- Electromagnetic compatibility EMC (immunity) *) 2014/30/EC

*) The compliance with EMC emission requirements must be checked after the burner management system is installed in equipment

Compliance with the regulations of the applied directives is verified by the adherence to the following standards / regulations:

- Automatic burner control systems for burners and appliances burning gaseous or liquid fuels DIN EN 298
- Safety and control devices for gas burners and gas burning appliances - Valve proving systems for automatic shut-off valves DIN EN 1643
- Gas/air ratio controls for gas burners and gas burning appliances - Part 2: Electronic types DIN EN 12067-2
- Safety and control devices for gas burners and gas burning appliances DIN EN 13611
- Safety and control devices for gas burners and gas-burning appliances - Particular requirements Part 1: Automatic and semi-automatic valves ISO 23552-1
- Automatic electrical controls for household and similar use Part 2-5: Particular requirements for automatic electrical burner control systems DIN EN 60730-2-5

The relevant valid edition of the standards can be found in the declaration of conformity!



Note on DIN EN 60335-2-102
Household and similar electrical appliances - Safety - Part 2-102: Particular requirements for gas, oil and solid-fuel burning appliances having electrical connections. The electrical connections of the LMV2 comply with the requirements of EN 60335-2-102.



EAC Conformity mark (Eurasian Conformity mark)



ISO 9001:2008
ISO 14001:2004
OHSAS 18001:2007



Life cycle

LMV36... The burner management system LMV36... has a designed lifetime* of 250,000 burner startup cycles which, under normal operating conditions in heating mode, correspond to approx. 10 years of usage (starting from the production date given on the type field).

AGM60... The AGM60... dual fuel switch unit has a designed lifetime* of 5,000 burner startup cycles which, under normal operating conditions in heating mode, correspond to approx. 10 years of usage (starting from the production date given on the type field).

General This lifetime is based on the endurance tests specified in standard EN 298. A summary of the conditions has been published by the European Control Manufacturers Association (Afecon) (www.afecor.org).

The designed lifetime is based on use of the LMV36... / AGM60... according to the manufacturer's Data Sheet and Basic Documentation. When reaching the designed lifetime in terms of the number of burner startup cycles or time of usage, the LMV36... / AGM60... must be replaced by authorized personnel.

* The designed lifetime is not the warranty time specified in the Terms of Delivery

Supplementary documentation

User Documentation Modbus AZL2.....	A7541
Environmental Product Declaration LMV2... / LMV3.....	E7541
Environmental Product Declaration AGM60.....	E7547
Installation and Operating Instructions PC Software ACS410.....	J7352
Basic Documentation LMV36... / AGM60.....	P7544
Product Range Overview LMV2... / LMV3.....	Q7541

System overview

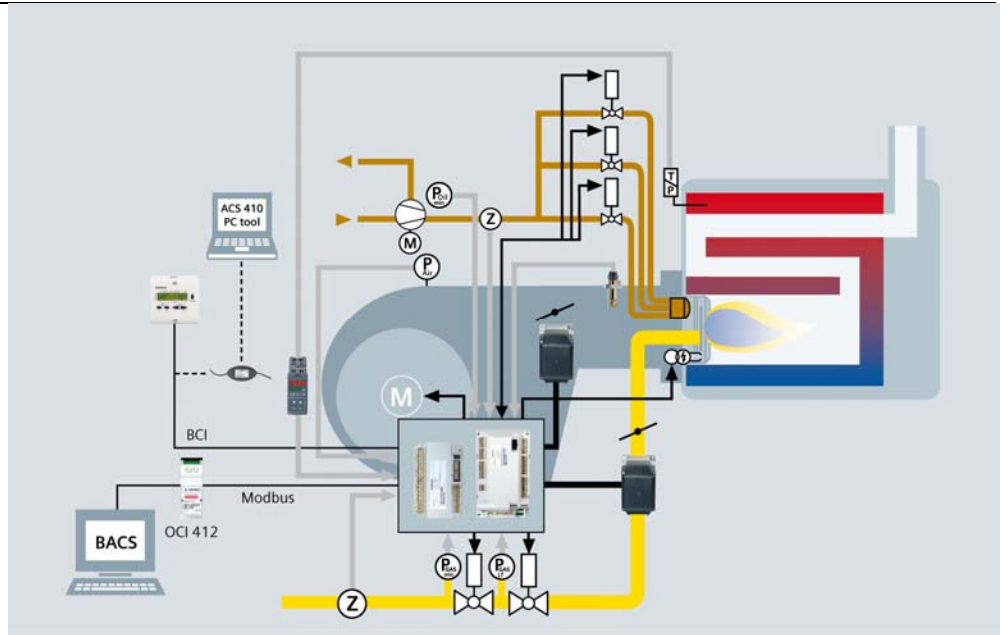

The diagram shows the full scope of functions of the LMV36... system. The actual functions are to be determined based on the respective execution / configuration!

Ordering

Burner control

LMV36...

The basic unit is the actual burner control featuring all-polar input / output terminals. No operating elements. Operation via detached ancillary units for wire-bound communication. See Basic Documentation P7544



Type	Mains voltage	Parameter set	Detectors
LMV36.520A1	AC 120 V	USA	QRA2... / QRA4... / QRA10... / QRB... / ION

Dual fuel switch unit

AGM60.4A9

Connected on the LMV36... basic unit. Used for switching the valve control or feedback signals and actuators of both fuels. See Basic Documentation P7544



Type	Mains voltage
AGM60.4A9	AC 120 V

Fuel selector

The fuel selector is **not** a component of the AGM60... and does **not** constitute part of the scope of delivery.

Service tools

OCI410... interface between burner management system and PC

Facilitates viewing, handling and recording setting parameters on site with the help of the ACS410 software package. See Data Sheet N7616



OCI412.10 Modbus interface

Device serving as an interface between the LMV36... and a Modbus system, such as a building automation and control system (BACS). The Modbus interface is based on the RS-485 standard. See Data Sheet N7615



ACS410

PC software for parameterization and visualization to the burner management system. See Software Documentation J7352

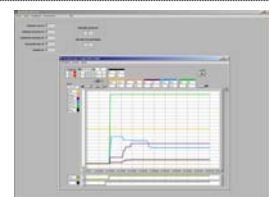

Display and operating units

AZL21.00A9

Detached display and operating unit, choice of mounting methods, 8-digit LCD, 5 buttons, BCI for LMV36... system, degree of protection IP40. See Data Sheet N7542



AZL23.00A9

Detached display and operating unit, choice of mounting methods, 8-digit LCD, 5 buttons, BCI for LMV36... system, degree of protection IP54. See Data Sheet N7542



Flame detectors

QRA2...

Flame detector for use with Siemens burner controls, for the supervision of gas flames and yellow- / blue-burning oil flames as well as ignition spark checking. Plastic housing, metalized to prevent static charging caused by the air flow from the fan. For direct mounting on the burner. The detectors can be supplied with or without securing flange and clamp.

See Data Sheet N7712



QRA4...

Flame detector for use with Siemens burner controls, for the supervision of gas flames and yellow- or blue-burning oil flames as well as for ignition spark proving.

See Data Sheet N7711



QRA10...

Flame detector for use with Siemens burner controls, for the supervision of gas flames and yellow- / blue-burning oil flames as well as ignition spark checking.

Die-cast aluminium housing with a 1 in. mounting coupling and connection facility for cooling air. The housing of this detector has a bayonet fitting which allows it to be secured either directly to the 1 in. mounting coupling or to the AGG06. The 1 in. mounting coupling can be screwed to a viewing tube or to the AGG07. The Pg cable gland can be removed and replaced, if some other detector cable shall be used.

See Data Sheet N7712

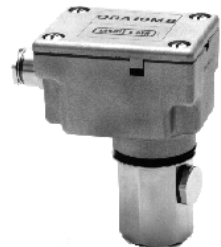

QRB...

Photo resistive flame detector for use with Siemens burner controls, for the supervision of oil flames in the visible light spectrum. Especially suited for use with burner controls for small capacity burners in intermittent operation.

See Data Sheet N7714



QRC...

Blue-flame detector for use with Siemens burner controls, for the supervision of blue- or yellow-burning oil or gas flames. Especially suited for use with burner controls for small capacity burners in intermittent operation.

See Data Sheet N7716

Frontal illumination:



Lateral illumination:



Actuators

SQM33.4...

Rated torque 1.2 Nm (0.8 Nm holding torque when dead),
running time 5 s, stepper motor, front mounting, D-type drive
shaft.

See Data Sheet N7813

SQM33.5...

Rated torque 3 Nm (2.6 Nm holding torque when dead),
running time 5 s, stepper motor, front mounting, D-type drive
shaft.

See Data Sheet N7813



SQM33.7...

Rated torque 10 Nm (6 Nm holding torque when dead),
running time 17 s, stepper motor, front mounting, D-type
drive shaft.

See Data Sheet N7813

SQN1...

Rated torque 1 Nm (0.2 Nm holding torque when dead),
running time 5 s, stepper motor, front mounting, D-type drive
shaft.

See Data Sheet N7803



Connector sets

AGG3.131

Complete connector set RAST2.5 / RAST3.5 / RAST5 for gas / oil applications, single pack.
See Object List C7541 (74 319 0637 0)

Example: X5-02



AGG3.132

Complete connector set RAST2.5 / RAST3.5 / RAST5 for gas- / oil applications, pack of 10.
See Object List C7541 (74 319 0637 0)

AGG9...

Single connectors
Packing unit 200 in total

Example X5-03



Type	Type of connector	Terminal
AGG9.203	RAST5	X3-02
AGG9.204	RAST5	X3-03
AGG9.206	RAST5	X8-04
AGG9.209	RAST5	X10-06
AGG9.217	RAST5	X75
AGG9.303	RAST5	X3-05
AGG9.304	RAST5	X4-02
AGG9.306	RAST5	X5-01
AGG9.307	RAST5	X5-02
AGG9.309	RAST5	X6-03
AGG9.310	RAST5	X7-01
AGG9.311	RAST5	X7-02
AGG9.313	RAST5	X9-04
AGG9.403	RAST5	X5-03
AGG9.406	RAST5	X8-02
AGG9.501	RAST5	X3-04
AGG9.504	RAST5	X10-05
AGG9.853	RAST3.5	X64 and X74

Accessories

AGG5.310

Accessories set speed control, for burner management systems, composed of sensor disk Ø 50, sensor and mounting set.
See Mounting instructions M7550.1 (74 319 9322 0)

Ordering (cont'd)

Cables

AGV50.100

Signal cable for AZL2..., with RJ11 connector, length 1 m, pack of 10

AGV50.300

Signal cable for AZL2..., with RJ11 connector, length 3 m, pack of 10

**AGV61.100**

Connecting cable between LMV36... and AGM60... (US), cable length 1 m



Ordering (cont'd)

Proportional controlling element with mounting plate

VKP

Proportional controlling element for mounting between threaded flanges in gas trains.
Refer to Data Sheet N7646



ASK33.1

Larger mounting plate required to replace existing mounting plate. Required for mounting the actuators SQM4 or SQM33.
Refer to Data Sheet N7646



ASK33.2

Additional mounting plate is required for mounting the actuator SQN13.
Refer to Data Sheet N7646



Gas damper for mounting kit

VKF41...C

Butterfly valves designed in intermediate flange design, for integration into gas trains.
Refer to Data Sheet N7632



ASK33.4

Mounting kit for mounting the actuators SQM33.5 on the butterfly valve VKF41...C.
Refer to Data Sheet N7632



Transformer

A5Q20002669

Transformer to increase ionization voltage for AC 120 V devices.
See User Documentation A7541.2



Connection and internal diagram LMV36...

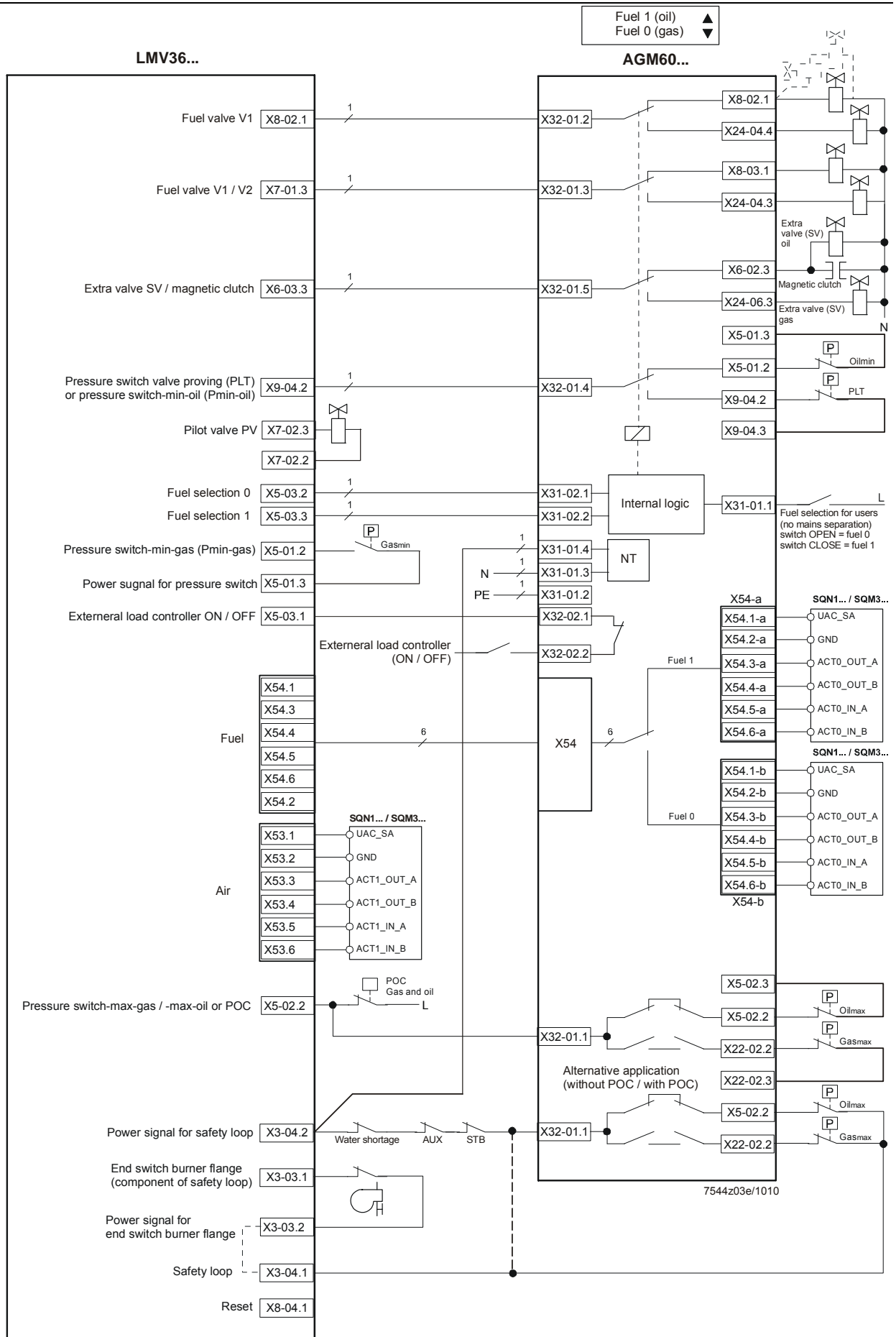

Connection and internal diagram LMV36... (cont'd)

Shielding:

For shielding the cables on the VSD, refer to:

- Siemens *SED2* VSD Commissioning Manual (G5192), chapters 4 and 7, or
- Danfoss Operation Manual *VLT 6000* (MG60A703), chapter *Installation*

Technical Data

Basic unit LMV36...

General

Mains voltage	AC 120 V -15% / +10%
Mains frequency	50 / 60 Hz ±6%
Power consumption	<30 W (typically)
Safety class	I with parts according to II and III to DIN EN 60730-1
Degree of protection	IP00

Note

The burner or boiler manufacturer must ensure degree of protection IP40 for LMV36... as per DIN EN 60529 through adequate installation.

Terminal loading «Inputs»

Perm. mains primary fuse (externally)	Max. 16 AT
Unit fuse F1 (internal)	6,3 AT (DIN EN 60127 2 / 5)
Mains supply: Input current depending on the operating state of the unit	
Undervoltage	
• Safety shutdown from operating position at mains voltage	Ca. AC 93 V
• Restart on rise in mains voltage	Ca. AC 95 V
Status inputs: Status inputs (with the exception of the safety loop) of the contact feedback network (CFN) are used for system supervision and require mains-related input voltage	
• Input safety loop	Refer to <i>Terminal loading outputs</i>
Input currents and input voltages	
- UeMax	UN +10%
- UeMin	UN -15%
- IeMax	1,5 mA peak
- IeMin	0,7 mA peak
Contact material recommendation for external signal sources (LP, Pmin, Pmax, etc.)	Gold-plated silver contacts
Transition / settling behavior / bounce	
- Perm. bounce time of contacts when switching on / off	Max. 50 ms (after the bounce time, contact must stay closed or open)
UN	AC 120 V
Voltage detection	
- On	AC 90...132 V
- Off	<AC 40 V

Technical Data (cont'd)

Terminal loading «Outputs»	Total contact loading:
	<ul style="list-style-type: none"> • Rated voltage AC 120 V, 50 / 60 Hz • Unit input current (safety loop) from: Max. 5 A <ul style="list-style-type: none"> - Fan motor contactor - Ignition transformer - Valves - Oil pump / magnetic clutch (optional via AGM60...)
	Individual contact loading:
	Fan motor contactor
	<ul style="list-style-type: none"> • Rated voltage AC 120 V, 50 / 60 Hz • Rated current 1.6 A pilot duty output declaration to UL372 • Power factor $\text{Cos}\phi > 0.4$
	Alarm output
	<ul style="list-style-type: none"> • Rated voltage AC 120 V, 50 / 60 Hz • Rated current 1 A • Power factor $\text{Cos}\phi > 0.4$
	Ignition transformer
	<ul style="list-style-type: none"> • Rated voltage AC 120 V, 50 / 60 Hz • Rated current 1.6 A pilot duty output declaration to UL372 or 250 VA ignition output declaration to UL372 • Power factor $\text{Cos}\phi > 0.2$
	Fuel valves
	<ul style="list-style-type: none"> • Rated voltage AC 120 V, 50 / 60 Hz • Rated current 1.6 A pilot duty output declaration to UL372 • Power factor $\text{Cos}\phi > 0.4$
	Operation display
	<ul style="list-style-type: none"> • Rated voltage AC 120 V, 50 / 60 Hz • Rated current 0,5 A • Power factor $\text{Cos}\phi > 0.4$
	Safety valve (SV) (magnetic clutch / oil pump)
	<ul style="list-style-type: none"> • Rated voltage AC 120 V, 50 / 60 Hz • Rated current 2 A • Power factor $\text{Cos}\phi > 0.4$
	Connections for pressure switch
	<ul style="list-style-type: none"> • Rated voltage AC 120 V, 50 / 60 Hz • Rated current 1.5 mA • Power factor ---
	Fuel feedback to LMV... (X31-02 pin 1 or X31-02 pin 2)
	<ul style="list-style-type: none"> • IaMax <10 mA
Analog output / load output X74 pin 3	Accuracy of output voltage $\pm 1 \%$

Technical Data (cont'd)

Cable lengths	Mains line AC 120 V	Max. 100 m (100 pF/m)
	Display, BCI	For installation under the burner hood or in the control panel Max. 3 m (100 pF/m)
	Load controller (LR) X5-03	Max. 20 m (100 pF/m)
	Load controller analog X64 (24 mA)	Max. 20 m (100 pF/m)
	Safety loop / burner flange (total)	Max. 20 m (100 pF/m)
	External lockout reset button	Max. 20 m (100 pF/m)
	Safety valve (SV)	Max. 20 m (100 pF/m)
	Load output ¹⁾	Max. 10 m (100 pF/m)
	VSD control ¹⁾²⁾	Max. 3 m (100 pF/m)
	Speed input	Max. 3 m (100 pF/m)
	Fuel valve (V1 / V2 / V3)	Max. 3 m (100 pF/m)
	Pilot valve (PV)	Max. 3 m (100 pF/m)
	Ignition transformer (Z)	Max. 3 m (100 pF/m)
	Other lines	Max. 3 m (100 pF/m)

¹⁾ Do not run the cable together with other cables. If not observed, hum voltage might cause electromagnetic interference

²⁾ Shorter cable length due to closed control loop

Specification as per EN 60730-1

Type of shutdown or interruption of each circuit

Shutdown with microswitch 1-pole

Mode of operation Type 2 B

Cross-sectional areas

The cross-sectional areas of the mains power lines (L, N, and PE) and, if required, the safety loop (safety limit thermostat, water shortage, etc.) must be sized for rated currents according to the selected external primary fuse. The cross-sectional areas of the other cables must be sized in accordance with the internal unit fuse (max. 6.3 AT).

Min. cross-sectional area	0.75 mm ² (single- or multi-core as per VDE 0100)
---------------------------	---

Cable insulation must meet the relevant temperature requirements and environmental conditions.

Fuses used inside the LMV36... basic unit

- F1	6.3 AT DIN EN 60127 2 / 5
------	---------------------------

Connections of actuators

The fixed connected actuator cables must not be extended.

AGV50... signal cable AZL2... → BCI

Signal cable	Color white Unshielded Conductor 4 x 0.141 mm ² With RJ11-plug
Cable length	
- AGV50.100	1 m
- AGV50.300	3 m
Other cable lengths	
- Supplier	Recommended: Hütter http://www.huetter.co.at/telefonkabel.htm
Location	Under the burner hood (extra measures required for SKII EN 60730-1)

Technical Data (cont'd)

Environmental conditions

Storage	DIN EN 60721-3-1
Climatic conditions	Class 1K3
Mechanical conditions	Class 1M2
Temperature range	-20...+60 °C
Humidity	<95 % r.h.
Transport	DIN EN 60721-3-2
Climatic conditions	Class 2K2
Mechanical conditions	Class 2M2
Temperature range	-30...+60 °C
Humidity	<95 % r.h.
Operation	DIN EN 60721-3-3
Climatic conditions	Class 3K3
Mechanical conditions	Class 3M3
Temperature range	-20...+60 °C
Humidity	<95 % r.h.



Caution!

Condensation, formation of ice and ingress of water are not permitted!

Flame supervision with ionization probe

No-load voltage at ION terminal (X10-05 pin 2)	Approx. U_{Mains}
--	---------------------



Caution!
The ionization probe must be protected against electric shock hazard (electric shock hazard)!

Short-circuit current	Max. AC 1 mA
Required detector current	Min. DC 4 μA , flame display approx. 30 %
Possible detector current	Max. DC 16...40 μA , flame display approx. 100 %
Max. perm. length of detector cable (laid separately)	3 m (wire-ground 100 pF/m)



Warning!
Simultaneous operation of QRA... and ionization probe is not permitted!



Note
 The higher the detector cable's capacitance (cable length), the more voltage at the ionization probe, and thus the detector current, drops. Long cable lengths plus very highly resistive flames might necessitate low-capacitance detector cables (e.g. ignition cable). In spite of technical measures taken in the circuitry aimed at compensating potential adverse effects of the ignition spark on the ionization current, it must be made certain that the minimum detector current required will already be reached during the ignition phase. If this is not the case, the connections on the primary side of the ignition transformer must be changed and / or the electrodes relocated.

Threshold values when flame is supervised by an ionization probe:

- Start prevention (extraneous light) Flame intensity (parameter 954) ≥ 18 %
- Operation Flame intensity (parameter 954) > 24 %

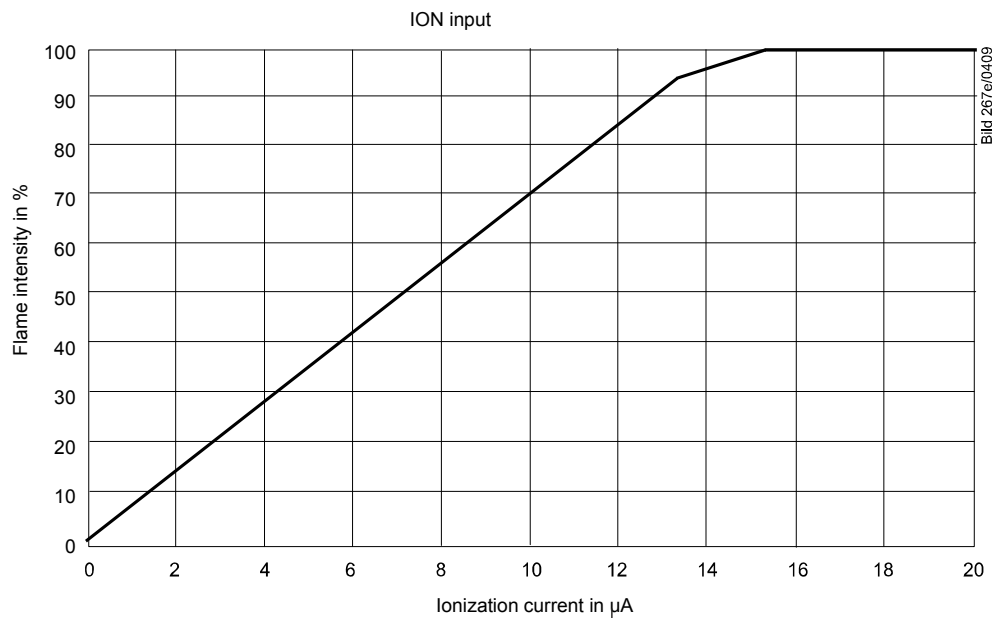

Measuring circuit for
detector current
measurement

Ionization probe

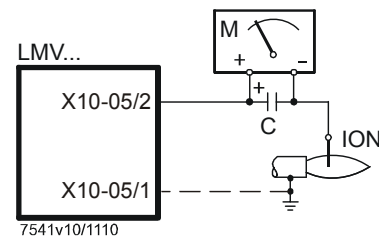

Legend

- C Electrolytic capacitor 100...470 μF ; DC 10...25 V
- ION Ionization probe
- M Microammeter R_i max. 5000 Ω

Flame supervision with
QRA2... / QRA4... /
QRA10...



Warning!

If flame detectors QRA2... / QRA4... / QRA10... are used for flame supervision with the LMV36..., it must be ensured that the basic unit is permanently connected to power (conforming to EN 298), thus enabling the system to detect flame detector failures during startup and shutdown. Generally, the system works with QRA... flame detectors in intermittent operation.

Technical Data refer to Data Sheet N7712 covering UV flame detectors QRA2... / QRA10...!

Technical Data refer to Data Sheet N7711 covering UV flame detectors QRA4...!

Operating voltage	Max. 350 V peak
Required detector current in operation	Min. 70 µA
Possible detector current in operation	Max. 600 µA
Permissible length of flame detector cable - normal cable (laid separately)	Max. 20 m

Threshold values when flame is supervised by QRA...:

- Start prevention (extraneous light)	Flame intensity (parameter 954) $\geq 18\%$
- Operation	Flame intensity (parameter 954) $> 24\%$

Measuring circuit for
detector current
measurement

UV flame detector QRA...

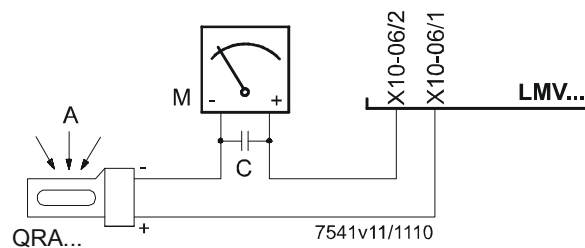

Legend

- A Incidence of light
- C Electrolytic capacitor 100...470 µF; DC 10...25 V
- M Microammeter R_i max. 5000 Ω



Warning!

- **Input QRA... is not short-circuit-proof!**
- **Short-circuits of X10-06/2 against earth can destroy the QRA... input**
- **Simultaneous operation of QRA... and ionization probe is not permitted!**

Flame supervision with QRB...

No-load voltage at QRB... terminal (X10-05 pin 3)	Approx. DC 5 V
Max. perm. length of QRB... detector cable (laid separately)	3 m (wire – wire 100 pF/m)

 **Note**
 A detector resistance of $R_F < 500 \Omega$ is identified as a short-circuit and leads to safety shutdown in operation as if the flame had been lost.

For this reason, before considering the use of a highly sensitive photoresistive detector (QRB1B... or QRB3S), it should be checked whether this type of flame detector is indeed required! Increased line capacitance between QRB... connection and mains live wire *L* has an adverse effect on the sensitivity and increases the risk of damaged flame detectors due to overvoltage. Always run detector cables separately!

Threshold values when flame is supervised by QRB...:	
Start prevention (extraneous light) with RQRB	Approx. 400 k Ω Flame intensity ≥ 10 %
Operation with RQRB	Approx. 230 k Ω Flame intensity > 16 %
Short-circuit detection with RQRB	$< 0,5$ k Ω

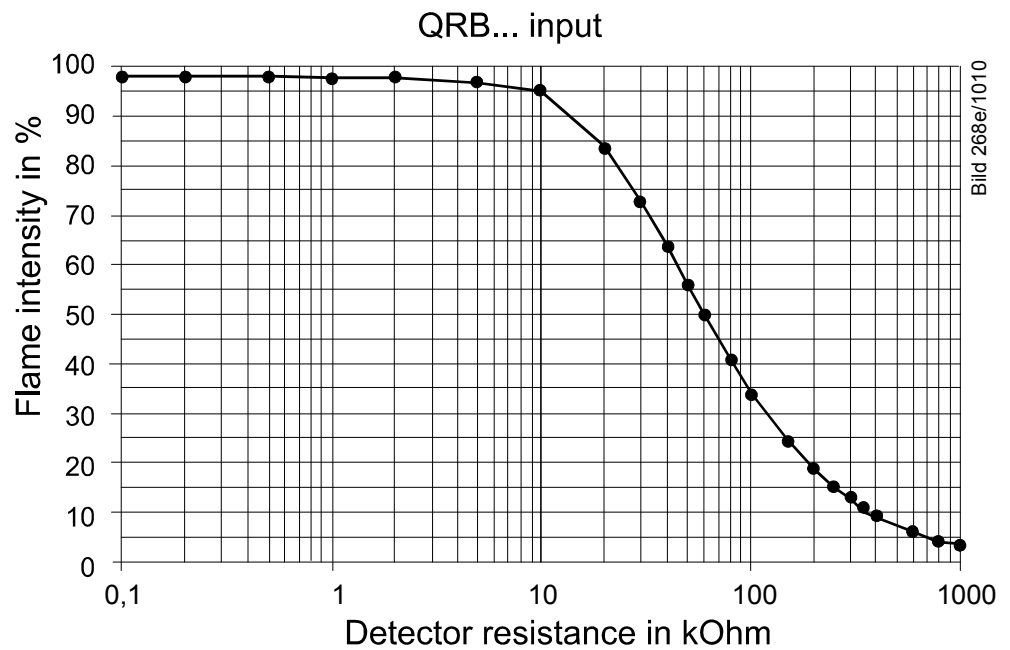

A flame detector resistance of $R_F < 500 \Omega$ is identified as a short-circuit and leads to safety shutdown in operation, like in the case of loss of flame.

Technical Data (cont'd)

Dual fuel switch unit AGM60...	Mains voltage	AC 120 V -15% / +10%
	Mains frequency	50/60 Hz ±6%
	Power consumption	<5 W (typically) (without actuator supply)
	Safety class	I with parts according to II and III to DIN EN 60730-1
	Galvanic separation between mains voltage terminals and actuator signal lines and actuator supply lines	No
	Degree of protection	IP00 Note: The burner or boiler manufacturer (OEM) must ensure degree of protection IP40 to DIN EN 60529 for burner controls by adequate installation of the AGM60... The AGM60... together with the LMV36... is suited for installation under the burner hood or inside a control cabinet or control panel
	Detection time fuel changeover	<400 ms
	Switching frequency fuel changeover	Min. 3 s
	Switching cycles fuel changeover	Max. 5'000
	Perm. mains primary fuse (externally)	Max. 6.3 AT Power must always be supplied via the basic unit (refer to chapter <i>Inputs / Outputs</i>)
	Mains supply: Input current depending on the operating state of the unit	
	Mains voltage is monitored by the burner control	
	Dimensions (W x H x D)	180.7 x 120.7 x 51.7 mm
	Mounting	Top hat rail to DIN EN 60715, 35 mm or screwed

Terminal output *Inputs*

Status input: Fuel selection, pressure switch	
• Input currents and input voltages	
- UeMax	UN +10%
- UeMin	UN -15%
- IeMax	1.5 mA peak
- IeMin	0.7 mA peak
• Contact material recommendation for external switching contact, transducer (Pmax, POC)	Gold-plated silver contacts
• Transition / settling behavior / bounce	
- Perm. bounce time of contacts when switching on/off	Max. 50 ms (after the bounce time, the contact must stay closed or open)
• UN	AC 120 V
• Voltage detection	
- On	AC 90...132 V
- Off	<AC 40 V

Technical Data (cont'd)

Terminal output *Outputs*

Total contact output:

- Rated voltage AC 120 V, 50/60 Hz

Refer also *Total contact output* in chapter *Terminal output Outputs*

Individual contact loads:

Fuel valve

- Rated voltage AC 120 V, 50/60 Hz
- Rated current 1.6 pilot duty output declaration to UL732
- Power factor $\text{Cos}\phi > 0.4$

Safety valve (SV) (magnetic clutch / oil pump)

- Rated voltage AC 120 V, 50/60 Hz
- Rated current 1.6 A pilot duty output declaration to UL732
- Power factor $\text{Cos}\phi > 0.4$

Connections for pressure switch

- Rated voltage AC 120 V, 50/60 Hz
- Rated current 1.5 mA
- Power factor ---

Power supply for pressure switch-max (Pmax) / POC (X5-02.3 or X22-02.3)

- IaMax <10 mA

Fuel feedback to LMV36... (X31-02.1 or X31-02.2)

- IaMax <10 mA

Cable lengths

Mains line LMV36... → AGM60... Max. 3 m (100 pF/m)

Fuel valves Max. 3 m (100 pF/m)

Other lines Max. 3 m (100 pF/m)

Fuel selector Max. 20 m (100 pF/m)

Load controller LR Max. 20 m (100 pF/m)

Specification as per EN 60730-1

Type of shutdown or interruption of each circuit

Shutdown with microswitch Single-pole

Mode of operation Type 2 B

Cross-sectional areas

The cross-sectional areas of the power supply lines (L, N and PE) must be capable of carrying the rated currents according to the built-in unit fuse of the respective basic unit (max. 6.3 AT).

Min. cross-sectional area 0.75 mm²
(single- or multi-core to VDE 0100)

Cable insulations must satisfy the relevant temperature requirements and environmental conditions.

Electrical connections of actuators

The fixed connected actuator cables must not be extended.

Technical Data (cont'd)

Environmental conditions	Storage	DIN EN 60721-3-1
	Climatic conditions	Class 1K3
	Mechanical conditions	Class 1M2
	Temperature range	-20...+60 °C
	Humidity	<95% r.h.
	Transport	DIN EN 60721-3-2
	Climatic conditions	Class 2K2
	Mechanical conditions	Class 2M2
	Temperature range	-30...+60 °C
	Humidity	<95% r.h.
	Operation	DIN EN 60721-3-3
	Climatic conditions	Class 3K3
Mechanical conditions	Class 3M3	
Temperature range	-20...+60 °C	
Humidity	<95% r.h.	



Caution!

Condensation, formation of ice and ingress of water are not permitted!

Dimensions

Dimensions in mm

LMV36...

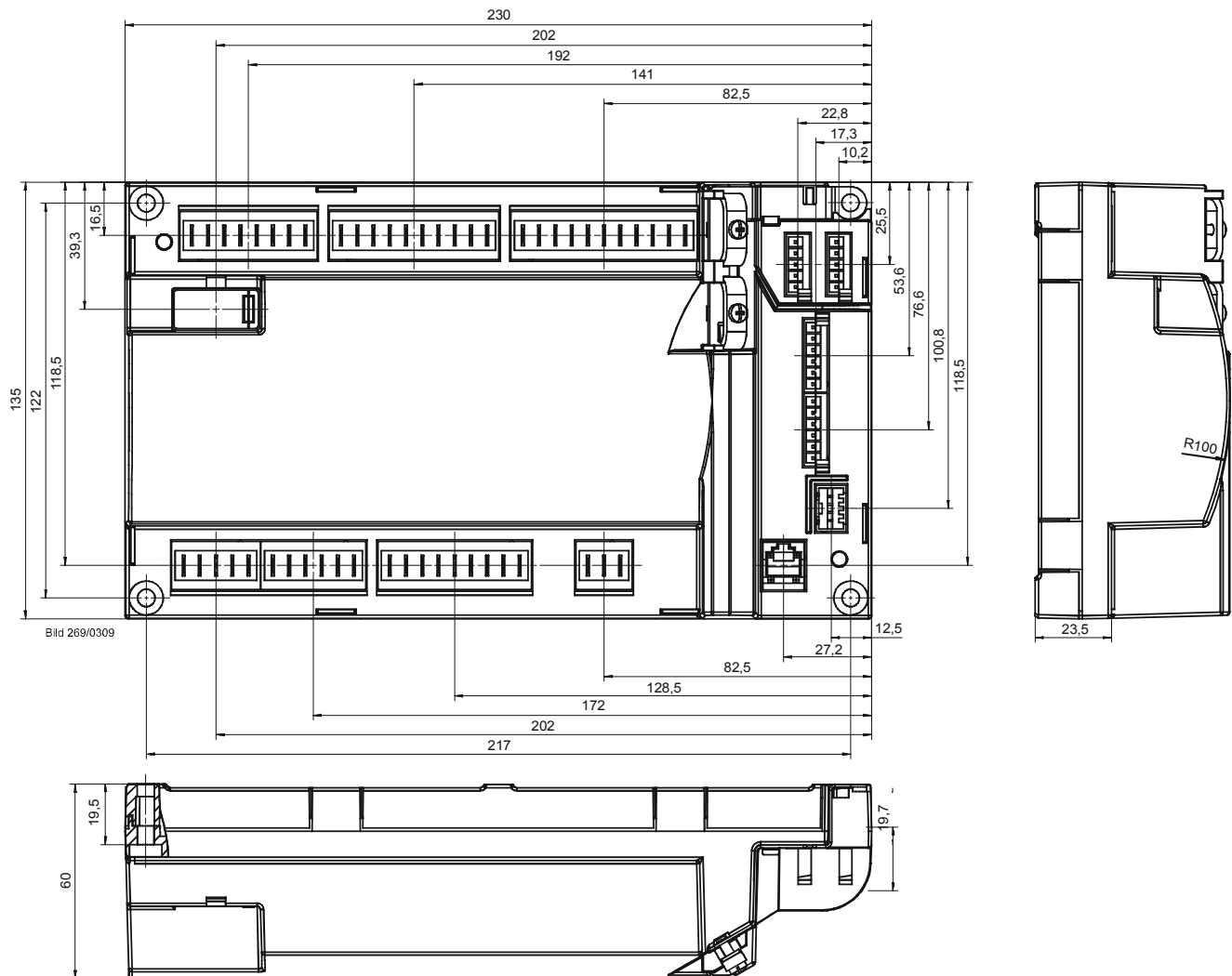

Dimensions (cont'd)

Dimensions in mm

AGM60...

